



Website



WhatsApp

CABLE TIES CABLE ACCESSORIES

HANGZHOU GORDON ELECTRIC CO., LTD.
NO.60 Xingqiao North Road, Linping District,
Hangzhou, Zhejiang 311100
China
www.gordon-elec.com

Tel. +86-571-8853 8375
Fax. +86-571-8853 8875
Email jeson@gordon-elec.com

COMPANY PROFILES



Hangzhou Gordon Electric Co., Ltd. was located in the beautiful west lake – Hangzhou City, nearby Shanghai port 200km, nearby Ningbo port 180km, the transportation is very convenient. Gordon Electric as a leading supplier for cable ties and cable accessories, our company has optimized human resources, strictly controlled management, improved product quality, strived to develop market, improved after-sales service and increased research input so as to realized sustainable and rapid development.

Products catch the certificates of UL, CE, RoHS, Reach, SGS and widely used in automation industrial, electronic industrial, wire hardness, information industrial. Our products are exported to many countries and regions such as United States, European Union, UAE, Mid East, South America, ASEAN etc.

Create the value for customers, create the better future with you...

Partners: Siemens, ABB, Benchmark, BOSSARD, Saudi Aramco, Dallas Trading, RDMP Pertamina etc.

QUALIFICATION CERTIFICATE

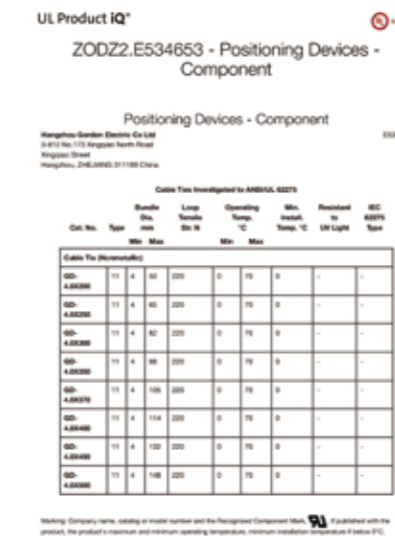

NYLON CABLE TIE



GORDON ELECTRIC



Self-Locking Nylon Cable Ties

Material: UL Approved Nylon 66/94V-2, corrosion resistant, well insulation, difficult to aging and strongly durable.

Working Temperature: -40°C to +85°C (-40°F to +185°F)

Color: Natural, Black and other colors customized

UL (Underwriters Laboratories): File No. E534653

ROHS, REACH Compliance

Nylon is inherent susceptible to environmental conditions. PA66 cable ties are moisturized to optimum performance level at machine-side and should be stored in cool and dry areas out of direct sunlight.

Cable ties are packaged in plastic bags and should remain sealed until ready for use.



UL (E534653) **RoHS Reach Halogen-Free PFAS-Free**

Item No.	Length		Width		Tensile Strength		Max. Bundle Dia.	
	mm	inch	mm	inch	kgs	lb	mm	inch
GD-2.5x60	60	2.4"	2.5	0.10	8kgs	18lb	11.00	0.43
GD-2.5x80	80	3.2"	2.5	0.10	8kgs	18lb	14.00	0.55
GD-2.5x100	100	4.0"	2.5	0.10	8kgs	18lb	20.50	0.81
GD-2.5x120	120	4.7"	2.5	0.10	8kgs	18lb	27.00	1.06
GD-2.5x150	150	6.0"	2.5	0.10	8kgs	18lb	36.50	1.44
GD-2.5x160	160	6.3"	2.5	0.10	8kgs	18lb	39.80	1.57
GD-2.5x200	200	8.0"	2.5	0.10	8kgs	18lb	52.50	2.07
GD-3.6x140	140	5.5"	3.6	0.14	18kgs	40lb	33.00	1.30
GD-3.6x150	150	6.0"	3.6	0.14	18kgs	40lb	35.00	1.38
GD-3.6x180	180	7.1"	3.6	0.14	18kgs	40lb	42.00	1.65
GD-3.6x200	200	8.0"	3.6	0.14	18kgs	40lb	50.00	1.97
GD-3.6x250	250	10"	3.6	0.14	18kgs	40lb	65.00	2.56
GD-3.6x280	280	11"	3.6	0.14	18kgs	40lb	70.00	2.76
GD-3.6x300	300	12"	3.6	0.14	18kgs	40lb	80.00	3.15
GD-3.6x370	370	14.6"	3.6	0.14	18kgs	40lb	105.00	4.13
GD-4.8x120	120	4.7"	4.8	0.19	22kgs	50lb	30.00	1.18
GD-4.8x160	160	6.3"	4.8	0.19	22kgs	50lb	40.00	1.57
GD-4.8x180	180	7.1"	4.8	0.19	22kgs	50lb	42.00	1.65
GD-4.8x190	190	7.5"	4.8	0.19	22kgs	50lb	46.00	1.81
GD-4.8x200	200	8.0"	4.8	0.19	22kgs	50lb	50.00	1.97
GD-4.8x250	250	10"	4.8	0.19	22kgs	50lb	65.00	2.56
GD-4.8x280	280	11"	4.8	0.19	22kgs	50lb	70.00	2.76
GD-4.8x300	300	12"	4.8	0.19	22kgs	50lb	80.00	3.15
GD-4.8x350	350	14"	4.8	0.19	22kgs	50lb	90.00	3.54
GD-4.8x360	360	14.2"	4.8	0.19	22kgs	50lb	94.00	3.70
GD-4.8x370	370	14.6"	4.8	0.19	22kgs	50lb	98.00	3.80
GD-4.8x380	380	15"	4.8	0.19	22kgs	50lb	102.00	4.02
GD-4.8x400	400	16"	4.8	0.19	22kgs	50lb	105.00	4.13
GD-4.8x430	430	16.9"	4.8	0.19	22kgs	50lb	120.00	4.72
GD-4.8x450	450	17.7"	4.8	0.19	22kgs	50lb	130.00	5.12
GD-4.8x500	500	19.7"	4.8	0.19	22kgs	50lb	150.00	5.90

Self-Locking Nylon Cable Ties

Material: UL Approved Nylon 66/94V-2, corrosion resistant, well insulation, difficult to aging and strongly durable.

Working Temperature: -40°C to +85°C (-40°F to +185°F)

Color: Natural, Black and other colors customized

UL (Underwriters Laboratories): File No. E534653

ROHS, REACH Compliance

Nylon is inherent susceptible to environmental conditions. PA66 cable ties are moisturized to optimum performance level at machine-side and should be stored in cool and dry areas out of direct sunlight.

Cable ties are packaged in plastic bags and should remain sealed until ready for use.



UL (E534653) **RoHS Reach Halogen-Free PFAS-Free**

Item No.	Length		Width		Tensile Strength		Max. Bundle Dia.	
	mm	inch	mm	inch	kgs	lb	mm	inch
GD-7.2x150	150	6.0"	7.2	0.3	55kgs	120lb	35.00	1.38
GD-7.2x200	200	8.0"	7.2	0.3	55kgs	120lb	50.00	1.97
GD-7.2x250	250	10"	7.2	0.3	55kgs	120lb	65.00	2.56
GD-7.2x280	280	11"	7.2	0.3	55kgs	120lb	78.00	3.07
GD-7.2x300	300	12"	7.2	0.3	55kgs	120lb	80.00	3.15
GD-7.2x350	350	14"	7.2	0.3	55kgs	120lb	90.00	3.54
GD-7.2x370	370	14.6"	7.2	0.3	55kgs	120lb	98.00	3.86
GD-7.2x380	380	15"	7.2	0.3	55kgs	120lb	100.00	3.94
GD-7.2x400	400	16"	7.2	0.3	55kgs	120lb	105.00	4.13
GD-7.2x450	450	18"	7.2	0.3	55kgs	120lb	110.00	4.33
GD-7.2x500	500	20"	7.2	0.3	55kgs	120lb	150.00	5.91
GD-7.2x530	530	20.9"	7.2	0.3	55kgs	120lb	160.00	6.30
GD-7.2x550	550	21.6"	7.2	0.3	55kgs	120lb	165.00	6.50
GD-7.2x600	600	23.6"	7.2	0.3	55kgs	120lb	170.00	6.69
GD-7.2x750	750	29.5"	7.2	0.3	55kgs	120lb	226.00	8.90
GD-9.0x400	400	16"	9.0	0.35	80kgs	175lb	105.00	4.13
GD-9.0x450	450	18"	9.0	0.35	80kgs	175lb	118.00	4.65
GD-9.0x500	500	20"	9.0	0.35	80kgs	175lb	150.00	5.91
GD-9.0x550	550	21.6"	9.0	0.35	80kgs	175lb	160.00	6.30
GD-9.0x600	600	23.6"	9.0	0.35	80kgs	175lb	170.00	6.69
GD-9.0x650	650	25.6"	9.0	0.35	80kgs	175lb	185.00	7.28
GD-9.0x720	720	28.3"	9.0	0.35	80kgs	175lb	195.00	7.68
GD-9.0x800	800	31.5"	9.0	0.35	80kgs	175lb	230.00	9.06
GD-9.0x900	900	35.5"	9.0	0.35	80kgs	175lb	265.00	10.43
GD-9.0x1000	1000	29.4"	9.0	0.35	80kgs	175lb	300.00	11.81
GD-9.0x1100	1100	43.3"	9.0	0.35	80kgs	175lb	335.00	13.19
GD-9.0x1200	1200	47.2"	9.0	0.35	80kgs	175lb	370.00	14.57
GD-12x500	500	20"	12	0.47	114kgs	250lb	150.00	5.91
GD-12x650	650	25.6"	12	0.47	114kgs	250lb	185.00	7.28
GD-12x700	700	27.5"	12	0.47	114kgs	250lb	190.00	7.65
GD-12x900	900	35.5"	12	0.47	114kgs	250lb	265.00	10.43

MOUNTING CABLE TIE

Material: UL Approved Nylon 66/94V-2, corrosion resistant, well insulation, difficult to aging.

Usage: After bundled wires, fix them on plate by screwing.

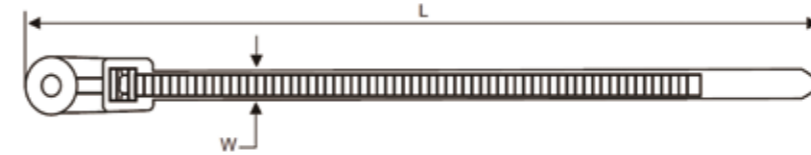

Item No.	Length		Width mm	Max. Bundle Dia. mm	Tensile Strength	
	inch	mm			lbs	kgs
MH-100MA	4"	100	2.5	22	18	8
MH-100	4"	100	3.6	22	40	18
MH-150	6"	150	3.6	32	40	18
MH-200	8"	200	4.8	42	50	22
MH-200A	8"	200	7.2	50	120	55
MH-300	12"	300	7.2	80	120	55
MH-350	14"	350	7.2	90	120	55

MARKER CABLE TIE

Material: UL Approved Nylon 66/94V-2, corrosion resistant, well insulation, difficult to aging.

Usage: Can make a mark on the blank tag at the head of the cable tie.



Item No.	Length		Width mm	Max. Bundle Dia. mm	Tensile Strength		Marker Size mm
	inch	mm			lbs	kgs	
MT-100	4"	100	2.5	22	18	8	25x8
MT-200	8"	200	4.6	50	50	22	28x13
MT-210	8.3"	210	3	55	18	8	28x20

RELEASABLE CABLE TIE - TYPE A

Material: UL Approved Nylon 66/94V-2, corrosion resistant, well insulation, difficult to aging.
Usage: Temporary or permanent bundling, and can quickly add or reduce strapping content.

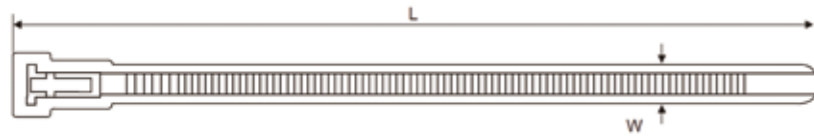

Item No.	Length		Width mm	Max. Bundle Dia. mm	Tensile Strength	
	inch	mm			lbs	kgs
RT-150	6"	150	7.2	35	50	22
RT-200	8"	200	7.2	50	50	22
RT-250	10"	250	7.2	65	50	22
RT-300	12"	300	7.2	80	50	22
RT-200MA	8"	200	4.8	50	40	18

RELEASABLE CABLE TIE - TYPE B

Material: UL Approved Nylon 66/94V-2, corrosion resistant, well insulation, difficult to aging.
Usage: Temporary or permanent bundling, and can quickly add or reduce strapping content.



Item No.	Length		Width mm	Max. Bundle Dia. mm	Tensile Strength	
	inch	mm			lbs	kgs
GD-R3.6x100	4"	100	3.6	22.6	18	22
GD-R4.8x160	6.3"	160	4.8	41.9	50	22
GD-R4.8x200	8"	200	4.8	54.8	50	22
GD-R4.8x300	12"	300	4.8	88.1	50	22
GD-R4.8x380	15"	380	4.8	111	50	22

DOUBLE LOCKING CABLE TIE

Material: UL Approved Nylon 66/94V-2, corrosion resistant, well insulation, difficult to aging.
Usage: Double locking design, strongly durable for securing and bundling of cables in the utility and construction industries.

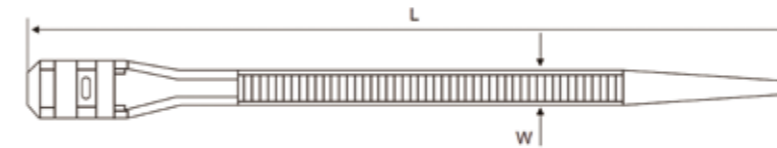

Item No.	Length		Width mm	Max. Bundle Dia. mm	Tensile Strength	
	inch	mm			lbs	kgs
DL-180	7"	180	9	45	88	40
DL-260	10 1/4"	260	9	66	110	50
DL-350	13 5/8"	350	9	90	110	50

DOUBLE HEAD CABLE TIE

Material: UL Approved Nylon 66/94V-2, corrosion resistant, well insulation, difficult to aging.



Item No.	Length		Width mm	D1		D2		Tensile Strength	
	inch	mm		max.	min.	max.	min.	lbs	kgs
RDCV-225	8 7/8"	225	4.8	59	2.5	52	2	50	22
RDCV-300	11 7/8"	300	4.8	83	2.5	76	2	50	22
RDCV-370	14 9/16"	370	4.8	105	2.5	98	2	50	22

PUSH MOUNT TIE

Material:UL Approved Nylon 66/94V-2,corrosion resistant,well insulation,difficult to aging.
Usage:Quick mounting one piece design securely attaches bundles to panel.



Item No.	Length		Width mm	Max.Bundle Dia. mm	Tensile Strength		Hole Dia		Panel Thickness	
	inch	mm			LBS	KGS	inch	mm	inch	mm
PM-100	4"	100	2.5	25	18	8	0.189	4.8	0.094	2.4
PM-150	6"	155	3.6	35	40	18	0.181	4.6	0.091	2.3
PM-200	8"	200	4.8	50	50	22	0.236	6	0.118	3

WIRE COLLECT TIE

Material: PE
Usage: Wrap electrical cords for shipping and packaging.Inexpensive and Reusable.



Item No.	Length		Width mm	Max.Bundle Dia. mm	Tensile Strength	
	inch	mm			LBS	KGS
WC-100	4"	100	=	25	18	8
WC-120	5.7"	145	=	40	18	8
WC-150	6.7"	170	=	50	30	14

HOOK&LOOP CABLE TIE(MAGIC CABLE TIE)

DIE-CUT CABLE TIE(AGGLUTINATION)
Reusable hook and loop cable ties,idea for temporary applications,strong and durable.



Item No.	Length		Width mm	Packing
	inch	mm		
HL-12x125	5"	125	12	10pcs
HL-12x150	6"	150	12	10pcs
HL-12x200	8"	200	12	10pcs
HL-12x240	9.4"	240	13	10pcs
HL-12x250	10"	250	21	10pcs

DIE-CUT CABLE TIE(ULTRASONIC WELDING)
Reusable hook and loop cable ties,idea for temporary applications,strong and durable.

Item No.	Length		Width mm	Packing
	inch	mm		
MG-10x180	7"	180	10	20pcs
MG-15x250	10"	250	15	20pcs

Note:Customer can select required products,according to their actual requirements.

HOOK & LOOP TIE(FASTENING TAPE)

Length: 25mm per roll.
Width: 12.5,16,20,25,30,38,50,75,100mm



Item No.	Width	Yard/Roll	Roll/Case	Quantity/Ctn
HLR-12.5	12.5mm	27.5y/r	60r	1650y
HLR-16	16mm	27.5y/r	60r	1650y
HLR-20	20mm	27.5y/r	50r	1375y
HLR-25	25mm	27.5y/r	40r	1100y
HLR-30	30mm	27.5y/r	32r	880y
HLR-38	38mm	27.5y/r	28r	770y
HLR-50	50mm	27.5y/r	20r	550y
HLR-75	75mm	27.5y/r	14r	385y
HLR-100	100mm	27.5y/r	10r	275y

35standard colors are available for our Hook&loop ties.Because it is different to organize,different to some extent while dying, generally regarding 80% as the acceptable standard to the color rate.

TIE GUN SERIES

GD-1, GD-2 TIE GUN

For fast and safe tensioning and cutting the cable ties off from 2.4mm to 4.8mm
Material: Plastic.



GD-3 TIE GUN

For fast and safe tensioning and cutting the cable ties off from 2.4mm to 4.8mm
Material: steel



GD-4 TIE GUN

For fast and safe tensioning and cutting the cable ties off from 4.8mm to 13mm
Material: steel



Value Pack Series (Nylon Cable Tie)

Item No.	GDVP-150	
Detail	2.5x100mm 4"	50PCS
	2.5x120mm 4.7"	50PCS
	3.6x200mm 8"	50PCS
Meas	46X24X44CM	
Qty	64SETS/CTN(32SETS/INNER BOX)	
Keeve	DIA: 5.5cm, HEIGHT: 21cm	



Item No.	GDVP-200	
Detail	2.5x100mm 4"	50PCS
	2.5x100mm 4"	50PCS
	2.5x120mm 4.7"	50PCS
	3.6x200mm 8"	50PCS
Meas	46X24X44CM	
Qty	64SETS/CTN(32SETS/INNER BOX)	
Keeve	DIA: 5.5cm, HEIGHT: 21cm	



Item No.	GDVP-250	
Detail	2.5x100mm 4"	50PCS
	2.5x100mm 4"	50PCS
	2.5x100mm 4"	50PCS
	2.5x100mm 4"	50PCS
	2.5x100mm 4"	50PCS
Meas	46X24X44CM	
Qty	64SETS/CTN(32SETS/INNER BOX)	
Keeve	DIA: 5.5cm, HEIGHT: 21cm	



Item No.	GDVP-300	
Detail	2.5x100mm 4"	25PCS
	2.5x100mm 4"	25PCS
	2.5x100mm 4"	50PCS
	2.5x100mm 4"	25PCS
	2.5x100mm 4"	25PCS
	4.8x200mm 8"	50PCS
	4.8x200mm 8"	50PCS
4.8x200mm 8"	50PCS	
Meas	38X38X44CM	
Qty	50SETS/CTN(25SETS/INNER BOX)	
Keeve	DIA: 7cm, HEIGHT: 21cm	



Value Pack Series (Nylon Cable Tie)

Item No.	GDVP-400	
Detail	2.5x100mm 4"	25PCS
	4.8x200mm 8"	50PCS
	4.8x200mm 8"	50PCS
	4.8x200mm 8"	50PCS
Meas	38X38X44CM	
Qty	50SETS/CTN(25SETS/INNER BOX)	
Keeve	DIA: 7cm, HEIGHT: 21cm	



Item No.	GDVP-500	
Detail	2.5x100mm 4"	100PCS
	2.5x120mm 4.7"	100PCS
	3.6x150mm 6"	150PCS
	2.5x200mm 8"	150PCS
Meas	38X38X44CM	
Qty	50SETS/CTN(25SETS/INNER BOX)	
Keeve	DIA: 7cm, HEIGHT: 21cm	



Item No.	GDVP-600	
Detail	2.5x100mm 4"	200PCS
	3.6x140mm 5.5"	100PCS
	3.6x150mm 6"	100PCS
	3.6x180mm 7"	100PCS
	4.8x200mm 8"	100PCS
Meas	59X29X38CM	
Qty	16SETS/CTN	
Keeve	L x W x H: 25.5x25x4.3CM	



Item No.	GDVP-800	
Detail	2.5x100mm 4"	300PCS
	3.6x140mm 5.5"	200PCS
	4.8x180mm 7"	200PCS
	4.8x200mm 8"	100PCS
	CABLE CUTTER	1PC
Meas	52X40X48CM	
Qty	24SETS/CTN(12SETS/INNER BOX)	
Keeve	DIA: 12cm, HEIGHT: 21cm	



Value Pack Series (Nylon Cable Tie)

Item No.	GDVP-850	
Detail	2.5x100mm 4"	400PCS
	3.6x140mm 5.5"	300PCS
	4.8x250mm 7"	100PCS
	4.8x300mm 8"	50PCS
Meas	52X42X33CM	
Qty	20SETS/CTN(10SETS/INNER BOX)	
Keeve	DIA: 10cm, HEIGHT: 31cm	



Item No.	GDVPS-200	
Detail	2.5x150mm 6"	200PCS
Meas	35X30X36CM	
Qty	60SETS/CTN(30SETS/INNER BOX)	



Item No.	GDVPS-800	
Detail	2.5x100mm 4"	200PCS
	2.5x120mm 4.7"	200PCS
	2.5x150mm 6"	150PCS
	3.6x180mm 6"	100 PCS
	3.6x200mm 7"	80PCS
	4.8X250mm 10"	50PCS
	4.8x300mm 12"	20PCS
Meas	57X46X52CM	



Item No.	GDVPS-850	
Detail	2.5x100mm 4"	450PCS
	2.5x120mm 4.7"	350PCS
	2.5x150mm 6"	150PCS
	4.8x280mm 11"	50PCS
Meas	57X38X25CM	



STAINLESS STEEL CABLE TIE



GORDON ELECTRIC



STAINLESS STEEL CABLE TIES-BALL LOCK TYPE

All length are available, Stainless steel type: 201, 304, 316, Special sizes can be customized;
 Characteristic: They have a unique ball locking mechanism that allow easily and quickly installed and not undone;
 High tensile strength: Non-flammability High resistance to acetic acid, alkali acid, sulphuric acid, corrode... etc;
 Working temperature: -60°C~150°C



Item No.	Approx. Length mm(inch)	Approx. Width mm(inch)	Max. Bundle Dia. mm(inch)	Min. Loop Tensile Strength n(Lbs)
GDST-4.6x150	150(5.9)	4.6(0.181)	37(1.46)	600(135)
GDST-4.6x200	200(7.87)		50(1.97)	
GDST-4.6x250	250(9.84)		63(2.48)	
GDST-4.6x300	300(11.8)		76(2.99)	
GDST-4.6x350	350(13.78)		89(3.50)	
GDST-4.6x400	400(15.75)		102(4.02)	
GDST-4.6x450	450(17.72)		115(4.53)	
GDST-4.6x500	500(19.69)		128(5.04)	
GDST-4.6x550	550(21.65)		141(5.55)	
GDST-4.6x600	600(23.62)		154(6.06)	
GDST-7.9x150	150(5.9)	7.9(0.311)	37(1.46)	800(180)
GDST-7.9x200	200(7.87)		50(1.97)	
GDST-7.9x250	250(9.84)		63(2.48)	
GDST-7.9x300	300(11.8)		76(2.99)	
GDST-7.9x350	350(13.78)		89(3.50)	
GDST-7.9x400	400(15.75)		102(4.02)	
GDST-7.9x450	450(17.72)		115(4.53)	
GDST-7.9x500	500(19.69)		128(5.04)	
GDST-7.9x550	550(21.65)		141(5.55)	
GDST-7.9x600	600(23.62)		154(6.06)	
GDST-7.9x650	650(25.59)		167(6.57)	
GDST-7.9x700	700(27.56)		180(7.09)	
GDST-7.9x750	750(29.53)		191(7.52)	
GDST-7.9x800	800(31.5)		193(7.59)	
GDST-12x200	200(7.87)	12(0.472)	50(1.97)	1200(270)
GDST-12x250	250(9.84)		63(2.48)	
GDST-12x300	300(11.8)		76(2.99)	
GDST-12x350	350(13.78)		89(3.50)	
GDST-12x400	400(15.75)		102(4.02)	
GDST-12x450	450(17.72)		115(4.53)	
GDST-12x500	500(19.69)		128(5.04)	
GDST-12x550	550(21.65)		141(5.55)	
GDST-12x600	600(23.62)		154(6.06)	
GDST-12x650	650(25.59)		167(6.57)	
GDST-12x700	700(27.56)	180(7.09)		

COATED STAINLESS STEEL CABLE TIES-BALL LOCK TYPE

All length are available,Stainless steel type:201,304,316,Special sizes can be customized;
 Characteristic:They have a unique ball locking mechanism that allow easily and quickly installed and not undone;
 High tensile strenght: Non-flammability High resistance to acetic acid, alkali acid,sulphuric acid,corrode...etc;
 Feature: Coated band provide additional edge protection, prevent the corrosion between dissimilar materials.
 Working temperature: -60°C~150°C



Item No.	Approx.Length mm(inch)	Approx.Width mm(inch)	Max.Bundle Dia. mm(inch)	Min.Loop Tensile Strength n(Lbs)
GDCST-4.6x150	150(5.9)	4.6(0.181)	37(1.46)	600(135)
GDCST-4.6x200	200(7.87)		50(1.97)	
GDCST-4.6x250	250(9.84)		63(2.48)	
GDCST-4.6x300	300(11.8)		76(2.99)	
GDCST-4.6x350	350(13.78)		89(3.50)	
GDCST-4.6x400	400(15.75)		102(4.02)	
GDCST-4.6x450	450(17.72)		115(4.53)	
GDCST-4.6x500	500(19.69)		128(5.04)	
GDCST-4.6x550	550(21.65)		141(5.55)	
GDCST-4.6x600	600(23.62)		154(6.06)	
GDCST-7.9x150	150(5.9)	7.9(0.311)	37(1.46)	800(180)
GDCST-7.9x200	200(7.87)		50(1.97)	
GDCST-7.9x250	250(9.84)		63(2.48)	
GDCST-7.9x300	300(11.8)		76(2.99)	
GDCST-7.9x350	350(13.78)		89(3.50)	
GDCST-7.9x400	400(15.75)		102(4.02)	
GDCST-7.9x450	450(17.72)		115(4.53)	
GDCST-7.9x500	500(19.69)		128(5.04)	
GDCST-7.9x550	550(21.65)		141(5.55)	
GDCST-7.9x600	600(23.62)		154(6.06)	
GDCST-7.9x650	650(25.59)	167(6.57)		
GDCST-7.9x700	700(27.56)	180(7.09)		
GDCST-7.9x750	750(29.53)	191(7.52)		
GDCST-7.9x800	800(31.5)	193(7.59)		
GDCST-12x200	200(7.87)	12(0.472)	50(1.97)	1200(270)
GDCST-12x250	250(9.84)		63(2.48)	
GDCST-12x300	300(11.8)		76(2.99)	
GDCST-12x350	350(13.78)		89(3.50)	
GDCST-12x400	400(15.75)		102(4.02)	
GDCST-12x450	450(17.72)		115(4.53)	
GDCST-12x500	500(19.69)		128(5.04)	
GDCST-12x550	550(21.65)		141(5.55)	
GDCST-12x600	600(23.62)		154(6.06)	
GDCST-12x650	650(25.59)		167(6.57)	
GDCST-12x700	700(27.56)	180(7.09)		

FULL COATED STAINLESS STEEL CABLE TIES-BALL LOCK TYPE

All length are available,Stainless steel type:201,304,316,Special sizes can be customized;
 Characteristic:They have a unique ball locking mechanism that allow easily and quickly installed and not undone;
 High tensile strenght: Non-flammability High resistance to acetic acid, alkali acid,sulphuric acid,corrode...etc;
 Feature: Full coated version will prevent static electricity.
 Coated band provide additional edge protection, prevent the corrosion between dissimilar materials.
 Working temperature: -60°C~150°C

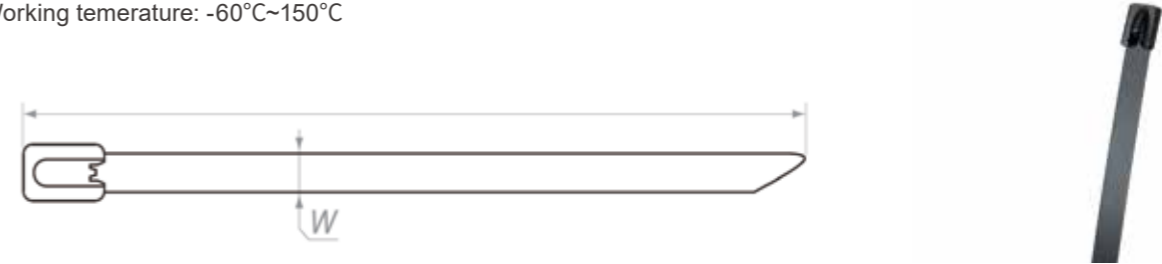

Item No.	Approx.Length mm(inch)	Approx.Width mm(inch)	Max.Bundle Dia. mm(inch)	Min.Loop Tensile Strength n(Lbs)
GDFCST-4.6x150	150(5.9)	4.6(0.181)	37(1.46)	600(135)
GDFCST-4.6x200	200(7.87)		50(1.97)	
GDFCST-4.6x250	250(9.84)		63(2.48)	
GDFCST-4.6x300	300(11.8)		76(2.99)	
GDFCST-4.6x350	350(13.78)		89(3.50)	
GDFCST-4.6x400	400(15.75)		102(4.02)	
GDFCST-4.6x450	450(17.72)		115(4.53)	
GDFCST-4.6x500	500(19.69)		128(5.04)	
GDFCST-4.6x550	550(21.65)		141(5.55)	
GDFCST-4.6x600	600(23.62)		154(6.06)	
GDFCST-7.9x150	150(5.9)	7.9(0.311)	37(1.46)	800(180)
GDFCST-7.9x200	200(7.87)		50(1.97)	
GDFCST-7.9x250	250(9.84)		63(2.48)	
GDFCST-7.9x300	300(11.8)		76(2.99)	
GDFCST-7.9x350	350(13.78)		89(3.50)	
GDFCST-7.9x400	400(15.75)		102(4.02)	
GDFCST-7.9x450	450(17.72)		115(4.53)	
GDFCST-7.9x500	500(19.69)		128(5.04)	
GDFCST-7.9x550	550(21.65)		141(5.55)	
GDFCST-7.9x600	600(23.62)		154(6.06)	
GDFCST-7.9x650	650(25.59)	167(6.57)		
GDFCST-7.9x700	700(27.56)	180(7.09)		
GDFCST-7.9x750	750(29.53)	191(7.52)		
GDFCST-7.9x800	800(31.5)	193(7.59)		
GDFCST-12x200	200(7.87)	12(0.472)	50(1.97)	1200(270)
GDFCST-12x250	250(9.84)		63(2.48)	
GDFCST-12x300	300(11.8)		76(2.99)	
GDFCST-12x350	350(13.78)		89(3.50)	
GDFCST-12x400	400(15.75)		102(4.02)	
GDFCST-12x450	450(17.72)		115(4.53)	
GDFCST-12x500	500(19.69)		128(5.04)	
GDFCST-12x550	550(21.65)		141(5.55)	
GDFCST-12x600	600(23.62)		154(6.06)	
GDFCST-12x650	650(25.59)		167(6.57)	
GDFCST-12x700	700(27.56)	180(7.09)		

STAINLESS STEEL CABLE TIES-LADDER MULTI BARB LOCK TYPE

Material:stainless steel 304&316,High corrosion resistant,multi barb-lock type,Good loop tensile strength can touch 250lbs;
Outdoor and indoor use,Ideal for applying in telecommunication,electricity,shipbuilding and oil& gas industry;
Working temperature:-60°C~150°C

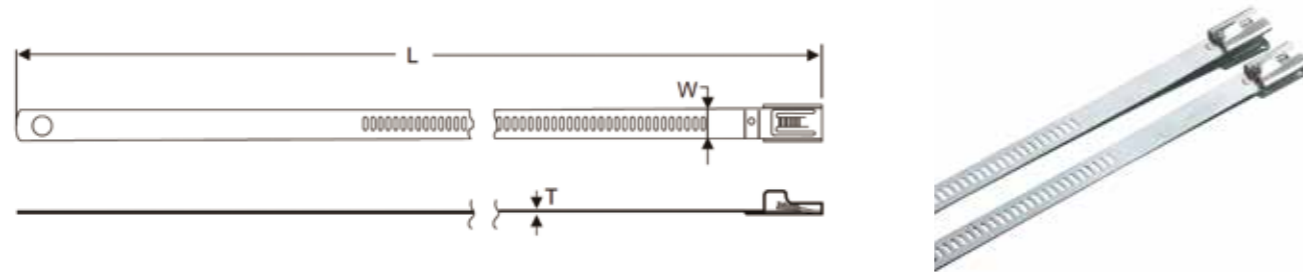

Item No.	Approx.Length mm(inch)	Approx.Width mm(inch)	Max.Bundle Dia. mm(inch)	Min.Loop Tensile Strength n(Lbs)
GDLST-7x150	150(5.9)	7 (0.276)	33(1.3)	1120 (252)
GDLST-7x225	225(8.86)			
GDLST-7x300	300(11.8)			
GDLST-7x335	335(13.2)			
GDLST-7x400	400(15.7)			
GDLST-7x450	450(17.7)			
GDLST-7x490	490(19.3)			
GDLST-7x550	550(21.7)			
GDLST-7x600	600(23.6)			
GDLST-7x650	650(25.6)			
GDLST-7x700	700(27.6)			
GDLST-7x750	750(29.5)			
GDLST-7x800	800(31.5)			
GDLST-12x150	150(5.9)		12 (0.472)	
GDLST-12x225	225(8.86)			
GDLST-12x300	300(11.8)			
GDLST-12x335	335(13.2)			
GDLST-12x400	400(15.7)			
GDLST-12x450	450(17.7)			
GDLST-12x490	490(19.3)			
GDLST-12x550	550(21.7)			
GDLST-12x600	600(23.6)			
GDLST-12x650	650(25.6)			
GDLST-12x700	700(27.6)			
GDLST-12x750	750(29.5)			
GDLST-12x800	800(31.5)			

STAINLESS STEEL CABLE TIES-RELEASABLE TYPE

Material: stainless steel 304&316,High tensile strength,Unique buckle design for quick,easy application;
Releasable use,ideal for applying in electricity,telecommunication,shipbuilding industry;
Working temperature: -60°C~150°C

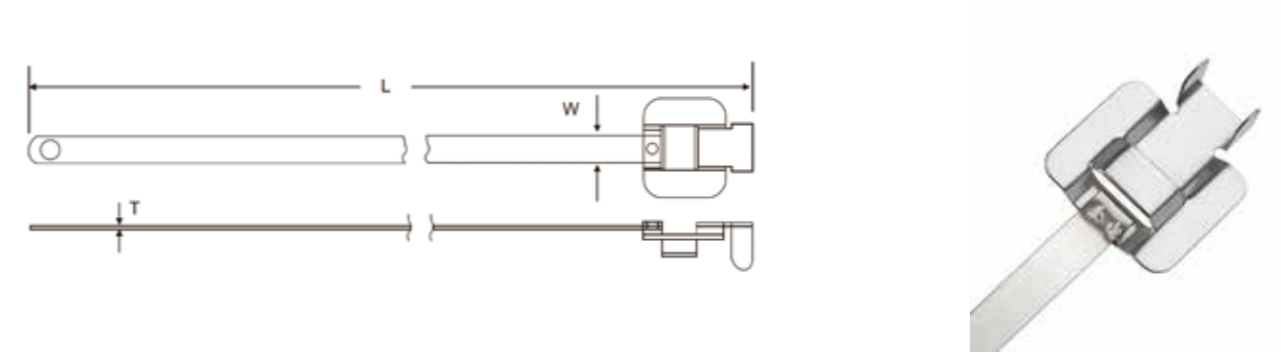

Item No.	Approx.Length mm(inch)	Approx.Width mm(inch)	Max.Bundle Dia. mm(inch)	Min.Loop Tensile Strength n(Lbs)
GDRST-10x150	150(5.9)	10 (0.39)	33(1.3)	1000 (225)
GDRST-10x190	190(7.5)			
GDRST-10x250	250(9.8)			
GDRST-10x300	300(11.8)			
GDRST-10x350	350(13.8)			
GDRST-10x400	400(15.7)			
GDRST-10x450	450(17.7)			
GDRST-10x490	490(19.3)			
GDRST-10x550	550(21.7)			
GDRST-10x600	600(23.6)			
GDRST-10x650	650(25.6)			
GDRST-10x700	700(27.6)			

COATED STAINLESS STEEL CABLE TIES-RELEASABLE TYPE

Material: stainless steel 304&316, High tensile strength, Unique buckle design for quick, easy application;
 Releasable use, ideal for applying in electricity, telecommunication, shipbuilding industry;
 Working temperature: -60°C~150°C

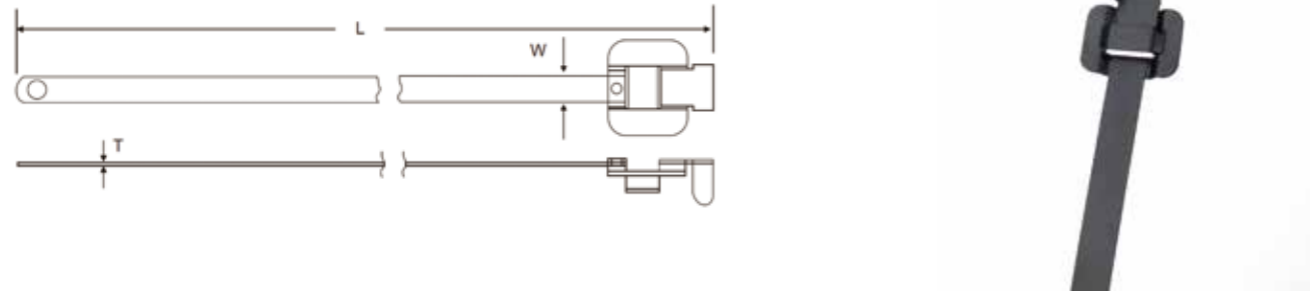

Item No.	Approx.Length mm(inch)	Approx.Width mm(inch)	Max.Bundle Dia. mm(inch)	Min.Loop Tensile Strength n(Lbs)
GDRST-10x150	150(5.9)	10 (0.39)	33(1.3)	1000 (225)
GDRST-10x190	190(7.5)		46(1.8)	
GDRST-10x250	250(9.8)		65(2.6)	
GDRST-10x300	300(11.8)		81(3.2)	
GDRST-10x350	350(13.8)		97(3.8)	
GDRST-10x400	400(15.7)		113(4.4)	
GDRST-10x450	450(17.7)		129(5.1)	
GDRST-10x490	490(19.3)		141(5.6)	
GDRST-10x550	550(21.7)		161(6.3)	
GDRST-10x600	600(23.6)		176(6.9)	
GDRST-10x650	650(25.6)		192(7.6)	
GDRST-10x700	700(27.6)		208(8.2)	

STAINLESS STEEL CABLE TIES-RATCHET-LOCK TYPE

Steel tie with Ratchet-locked banding buckle;
 Dedicated for hose bundling;
 Installed without professional tool.

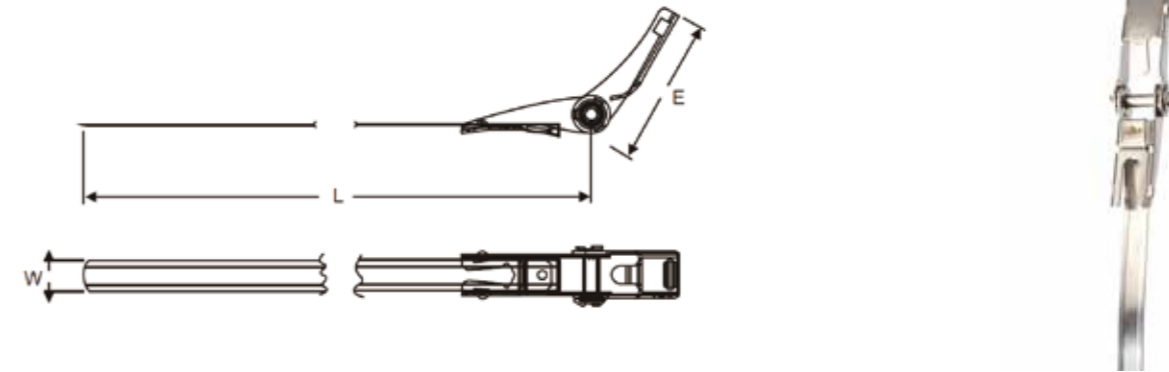

Item No.	Specification w x l
GDRST-400A	10x400
GDRST-600A	10x600
GDRST-800A	10x800
GDRST-900A	10x900
GDRST-1000A	10x1000
GDRST-1100A	10x1100
GDRST-1200A	10x1200
GDRST-1300A	10x1300
GDRST-1400A	10x1400
GDRST-1500A	10x1500
GDRST-400B	20x400
GDRST-600B	20x600
GDRST-800B	20x800
GDRST-900B	20x900
GDRST-1000B	20x1000
GDRST-1100B	20x1100
GDRST-1200B	20x1200
GDRST-1300B	20x1300
GDRST-1400B	20x1400
GDRST-1500B	20x1500

NYLON CABLE TIE WITH STAINLESS STEEL INLAY

Material and Features:made from nylon 66,steel inlay,good insulation,fire resistance,easy operation,time saving,etc.
Temperature: -40°C to 85°C standard tensile strength



Item No.	Specification wxl	Effective Length mm	The Maximum Binding Range	With Stand Force N	Packing pcs/bag
GDNS-3x100	3x100	80	25	50	200
GDNS-4x150	4x150	120	35	150	100
GDNS-4x200	4x200	170	50	150	100
GDNS-5x250	5x250	200	65	150	100
GDNS-5x300	5x300	115	80	150	100
GDNS-8x145	8x145	260	35	250	100
GDNS-8x175	8x175	145	45	250	100
GDNS-8x200	8x200	170	50	250	100
GDNS-8x240	8x240	200	60	250	100
GDNS-8x300	8x300	260	80	250	100
GDNS-8x400	8x400	360	110	250	100
GDNS-10x300	10x300	260	80	500	100
GDNS-10x350	10x350	310	95	500	100
GDNS-10x400	10x400	360	110	500	100
GDNS-10x450	10x450	410	130	500	100
GDNS-10x550	10x550	510	160	500	100
GDNS-10x600	10x600	560	175	500	100

STAINLESS STEEL CABLE TIES-L Type

Material: Material stainless steel 304,316, can produce a variety of lengths, special specifications according to customers samples of production.

Features: resistance Acid, corrosion resistance, tensile strength, L type HDLS protruding structure makes cable tie simple, fast and other advantages.

Operating temperature range: -60~550°C



Part number	Approx. length mm(inch)	Approx. width mm(inch)	Thickness	Max.Bundle Dia. mm(inch)	Min.loop tensile strength N(lbs)	Pcs/bag		
GDL-12x200	200 (8.0")	12 (0.47")	0.3	50 (2.0")	1200 (270)	100		
GDL-12x250	250 (10.0")		0.3	63 (2.5")		100		
GDL-12x300	300 (12.0")		0.3	76 (3.0")		100		
GDL-12x350	350 (14.0")		0.3	89 (3.5")		100		
GDL-12x400	400 (16.0")		0.3	102 (4.0")		100		
GDL-12x450	450 (18.0")		0.3	115 (4.5")		100		
GDL-12x500	500 (20.0")		0.3	128 (5.0")		100		
GDL-12x550	550 (21.6")		0.3	141 (5.6")		100		
GDL-16x250	250 (10.0")		15 (0.59")	0.3		63 (2.5")	1500 (337)	100
GDL-16x300	300 (12.0")			0.3		76 (3.0")		100
GDL-16x350	350 (14.0")	0.3		89 (3.5")	100			
GDL-16x400	400 (16.0")	0.3		102 (4.0")	100			
GDL-16x450	450 (18.0")	0.3		115 (4.5")	100			
GDL-16x500	500 (20.0")	0.3		128 (5.0")	100			
GDL-16x600	600 (23.6")	0.3		154 (6.0")	100			
GDL-16x700	700 (27.6")	0.3		180 (7.0")	100			
GDL-16x750	750 (30.0")	0.3		191 (7.5")	100			
GDL-16x800	800 (31.5")	0.3		193 (7.6")	100			
GDL-16x1000	1000 (40.0")	0.3	206 (8.0")	100				
GDL-19x300	300 (12.0")	19 (0.75")	0.4	76 (3.0")	2000 (440)	100		
GDL-19x400	400 (16.0")		0.4	102 (4.0")		100		
GDL-19x500	500 (20.0")		0.4	141 (5.6")		100		
GDL-19x600	600 (23.6")		0.4	154 (6.0")		100		
GDL-19x700	700 (27.6")		0.4	180 (7.0")		100		
GDL-19x800	800 (31.5")		0.4	193 (7.6")		100		
GDL-19x900	900 (36.0")		0.4	200 (8.0")		100		
GDL-19x1000	1000 (40.0")		0.4	206 (8.0")		100		

STAINLESS STEEL MARKER PLATE

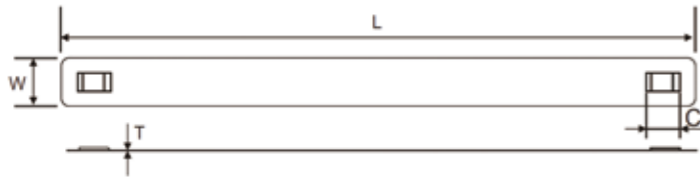

Item No.	L mm	W mm	C mm
GDPS-4.5	88.9	9.5	5.9
GDPM-4.5	88.9	19	6.2

STAINLESS STEEL BAND

Material: Stainless Steel 201 or 304 or 316

Specification: width 6.4mm-19.1mm

Features: high acid resistance, corrosion resistance; easy and convenient use.

Packing: 30.5m/roll, 50m/roll carton packaging, plastic box optional.

Different length can be packaged according to customer requirements.



Item No.	Width		Thickness		Average Breaking Strengt H(Lsb)	Package	
	mm	Inches	mm	Inches		(M/Roll)	(FT/Roll)
GD64038	6.4	1/4	0.38	0.015		30.5M/ROLL	100'/Roll
GD96038	9.6	3/8	0.38	0.015		30.5M/ROLL	100'/Roll
GD64051	6.4	1/4	0.51	0.020		30.5M/ROLL	100'/Roll
GD96051	9.6	3/8	0.51	0.020		30.5M/ROLL	100'/Roll
GD96051	9.6	3/8	0.51	0.020		30.5M/ROLL	100'/Roll
GD12751	12.7	1/2	0.51	0.020		30.5M/ROLL	100'/Roll
GD15851	15.8	5/8	0.51	0.020		30.5M/ROLL	100'/Roll
GD19151	19.1	1	0.51	0.020		30.5M/ROLL	100'/Roll
GD12764	12.7	1/2	0.64	0.025		30.5M/ROLL	100'/Roll
GD15864	15.8	5/8	0.64	0.025		30.5M/ROLL	100'/Roll
GD19164	19.1	1	0.64	0.025		30.5M/ROLL	100'/Roll
GD12776	12.7	1/2	0.76	0.030		30.5M/ROLL	100'/Roll
GD15876	15.8	5/8	0.76	0.030		30.5M/ROLL	100'/Roll
GD19176	19.1	1	0.76	0.030		30.5M/ROLL	100'/Roll

COATED STAINLESS STEEL BAND

Material: Stainless Steel 201 or 304 or 316

Specification: width 6.4mm-19.1mm

Features: high acid resistance, corrosion resistance; easy and convenient use.

Packing: 30.5mm/roll, 50m/roll carton packaging, plastic box optional.

Different length can be packaged according to customer requirements.



Item No.	Width		Thickness		Average Breaking Strength H(Lsb)	Package	
	mm	Inches	mm	Inches		(M/Roll)	(FT/Roll)
GDC64038	6.4	1/4	0.38	0.015		30.5M/ROLL	100'/Roll
GDC96038	9.6	3/8	0.38	0.015		30.5M/ROLL	100'/Roll
GDC64051	6.4	1/4	0.51	0.020		30.5M/ROLL	100'/Roll
GDC96051	9.6	3/8	0.51	0.020		30.5M/ROLL	100'/Roll
GDC96051	9.6	3/8	0.51	0.020		30.5M/ROLL	100'/Roll
GDC12751	12.7	1/2	0.51	0.020		30.5M/ROLL	100'/Roll
GDC15851	15.8	5/8	0.51	0.020		30.5M/ROLL	100'/Roll
GDC19151	19.1	1	0.51	0.020		30.5M/ROLL	100'/Roll
GDC12764	12.7	1/2	0.64	0.025		30.5M/ROLL	100'/Roll
GDC15864	15.8	5/8	0.64	0.025		30.5M/ROLL	100'/Roll
GDC19164	19.1	1	0.64	0.025		30.5M/ROLL	100'/Roll
GDC12776	12.7	1/2	0.76	0.030		30.5M/ROLL	100'/Roll
GDC15876	15.8	5/8	0.76	0.030		30.5M/ROLL	100'/Roll
GDC19176	19.1	1	0.76	0.030		30.5M/ROLL	100'/Roll

STAINLESS STEEL BUCKLE

Material: Stainless Steel 201 or 304 or 31

Features: high acid resistance, corrosion resistance; easy and convenient use.

Working temperature: -60°C~150°C



L Type Buckles

Item No.	Width		Packing pcs/bag
	mm	Inches	
BKLT-6.4	6.4	0.25	100
BKLT-9.5	9.5	0.38	100
BKLT-12.7	12.7	0.5	100
BKLT-15.9	15.9	0.63	100
BKLT-19	19	0.75	100



Wool Teeth Type Buckles

Item No.	Width		Packing pcs/bag
	mm	Inches	
BKW-6.4	6.4	0.25	100
BKW-9.5	9.5	0.38	100
BKW-12.7	12.7	0.5	100
BKW-15.9	15.9	0.63	100
BKW-19	19	0.75	100



S Type Buckles

Item No.	Width		Packing pcs/bag
	mm	Inches	
BKS-6.4	6.4	0.25	100
BKS-9.5	9.5	0.38	100
BKS-12.7	12.7	0.5	100
BKS-15.9	15.9	0.63	100
BKS-19	19	0.75	100

Hand Tools

ITEM NO.: GD-LBG

Tool type:LBG Cable Tie Gun

For type of cable tie: Stainless Steel Ties

For tiw width: 3.8mm-9mm

- Feature:
- Automatic gun, easy to install with single hand operation.
 - Cable tie side entry, for immediate positioning of the tie and the tool.
 - Controlled tension, fully adjustable to achieve desired tension.
 - Automatically cut off, when tension is reached.
 - Easy removal of excess tie.



ITEM NO.: GD-LQG

Tool type:LQG Tensioning Tool

For type of cable tie: Stainless Steel Ties

For tiw width: 3.8mm-9mm

- Feature:
- One hand operated tool.
 - Tension and cut-off.
 - Easy removal of excess tie.
 - Cable tie side entry, for immediate positioning of the tie and the tool.
 - Rugged, lightweight,easy to operate Plier type tool.
 - Provide mechanical advantage.



ITEM NO.: GD-LQD

Tool type:LQD Strapping Tool

For type of cable tie: Stainless Steel Ties;Stainless Steel Bands

For tiw width: 4.6mm-19mm

- Feature:
- Tension and cut off.
 - Unique 3-way handle can be used in various positions.
 - Specially useful in tight areas with minimal access.



ITEM NO.: GD-DQL

Tool type:DQL Crimping Tool

For type of cable tie: Stainless Steel Ties;Stainless Steel Band

For tiw width: 8mm-19mm

- Feature:
- Tension and cut off.
 - Spring loaded gripper lever improves ease of use and hand tensioning.
 - For tensions over 2,400 lbs of force application.
 - Cut off the tail,when the clamp is set up.



American Type Hose Clamp(8mm Band)

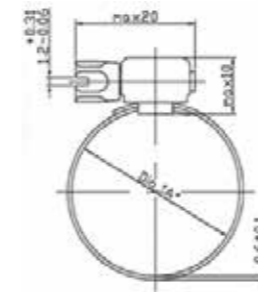

Material	Band	Housing	Screw
W1	Zinc plated steel	Zinc plated steel	Zinc plated steel
W2	SS201/301	SS201/301	Zinc plated steel
W2B	SS201	Zinc plated steel	Zinc plated steel
W4	SS201/301/304	SS201/301/304	SS201/301/304
W5	SS316	SS316	SS316

Item No.	Use Range/ Size(mm)	Band Width(mm)	Material
GDAH-0616	6-16	8	Zinc plated steel/SS201/304/316
GDAH-1120	11-20	8	Zinc plated steel/SS201/304/316
GDAH-1323	13-23	8	Zinc plated steel/SS201/304/316
GDAH-1427	14-27	8	Zinc plated steel/SS201/304/316
GDAH-1832	18-32	8	Zinc plated steel/SS201/304/316

American Type Hose Clamp(12.7mm Band)



Material	Band	Housing	Screw
W1	Zinc plated steel	Zinc plated steel	Zinc plated steel
W2	SS201/301	SS201/301	Zinc plated steel
W2B	SS201	Zinc plated steel	Zinc plated steel
W4	SS201/301/304	SS201/301/304	SS201/301/304
W5	SS316	SS316	SS316

Item No.	Use Range/ Size(mm)	Band Width(mm)	Material
GDAH-1120	11-20	12.7	Zinc plated steel/SS201/304/316
GDAH-1323	13-23	12.7	Zinc plated steel/SS201/304/316
GDAH-1427	14-27	12.7	Zinc plated steel/SS201/304/316
GDAH-1832	18-32	12.7	Zinc plated steel/SS201/304/316
GDAH-2138	21-38	12.7	Zinc plated steel/SS201/304/316
GDAH-2144	21-44	12.7	Zinc plated steel/SS201/304/316
GDAH-2751	27-51	12.7	Zinc plated steel/SS201/304/316
GDAH-3357	33-57	12.7	Zinc plated steel/SS201/304/316
GDAH-4064	40-64	12.7	Zinc plated steel/SS201/304/316
GDAH-4670	46-70	12.7	Zinc plated steel/SS201/304/316
GDAH-5276	52-76	12.7	Zinc plated steel/SS201/304/316
GDAH-5982	59-82	12.7	Zinc plated steel/SS201/304/316
GDAH-6589	65-89	12.7	Zinc plated steel/SS201/304/316
GDAH-7295	72-95	12.7	Zinc plated steel/SS201/304/316
GDAH-78102	78-102	12.7	Zinc plated steel/SS201/304/316
GDAH-84108	84-108	12.7	Zinc plated steel/SS201/304/316
GDAH-91114	91-114	12.7	Zinc plated steel/SS201/304/316
GDAH-105127	105-127	12.7	Zinc plated steel/SS201/304/316
GDAH-118140	118-140	12.7	Zinc plated steel/SS201/304/316
GDAH-130152	130-152	12.7	Zinc plated steel/SS201/304/316
GDAH-141165	141-165	12.7	Zinc plated steel/SS201/304/316
GDAH-155178	155-178	12.7	Zinc plated steel/SS201/304/316
GDAH-175197	175-197	12.7	Zinc plated steel/SS201/304/316
GDAH-196216	196-216	12.7	Zinc plated steel/SS201/304/316
GDAH-213235	213-235	12.7	Zinc plated steel/SS201/304/316
GDAH-232254	232-254	12.7	Zinc plated steel/SS201/304/316
GDAH-251273	251-273	12.7	Zinc plated steel/SS201/304/316
GDAH-270292	270-292	12.7	Zinc plated steel/SS201/304/316
GDAH-289311	289-311	12.7	Zinc plated steel/SS201/304/316
GDAH-300	300	12.7	Zinc plated steel/SS201/304/316
GDAH-400	400	12.7	Zinc plated steel/SS201/304/316

9MM Width Germany Type Hose Clamp



Material	Band	Housing	Screw
W1	Zinc plated steel	Zinc plated steel	Zinc plated steel
W2	SS201/301	SS201/301	Zinc plated steel
W4	SS201/301/304	SS201/301/304	SS201/301/304
W5	SS316	SS316	SS316

Item No.	Use Range/ Size(mm)	Band Width(mm)	Material
GDGH-0812	8-12	9	Zinc plated steel/SS201/304/316
GDGH-1016	10-16	9	Zinc plated steel/SS201/304/316
GDGH-1222	12-22	9	Zinc plated steel/SS201/304/316
GDGH-1627	16-27	9	Zinc plated steel/SS201/304/316
GDGH-2032	20-32	9	Zinc plated steel/SS201/304/316
GDGH-2540	25-40	9	Zinc plated steel/SS201/304/316
GDGH-3045	30-45	9	Zinc plated steel/SS201/304/316
GDGH-3550	35-50	9	Zinc plated steel/SS201/304/316
GDGH-4060	40-60	9	Zinc plated steel/SS201/304/316
GDGH-5070	50-70	9	Zinc plated steel/SS201/304/316
GDGH-6080	60-80	9	Zinc plated steel/SS201/304/316
GDGH-7090	70-90	9	Zinc plated steel/SS201/304/316
GDGH-80100	80-100	9	Zinc plated steel/SS201/304/316
GDGH-90110	90-110	9	Zinc plated steel/SS201/304/316
GDGH-100120	100-120	9	Zinc plated steel/SS201/304/316
GDGH-110130	110-130	9	Zinc plated steel/SS201/304/316
GDGH-120140	120-140	9	Zinc plated steel/SS201/304/316
GDGH-130150	130-150	9	Zinc plated steel/SS201/304/316
GDGH-140160	140-160	9	Zinc plated steel/SS201/304/316
GDGH-150170	150-170	9	Zinc plated steel/SS201/304/316
GDGH-160180	160-180	9	Zinc plated steel/SS201/304/316
GDGH-170190	170-190	9	Zinc plated steel/SS201/304/316

12MM Width Germany Type Hose Clamp



Material	Band	Housing	Screw
W1	Zinc plated steel	Zinc plated steel	Zinc plated steel
W2	SS201/301	SS201/301	Zinc plated steel
W4	SS201/301/304	SS201/301/304	SS201/301/304
W5	SS316	SS316	SS316

Item No.	Use Range/ Size(mm)	Band Width(mm)	Material
GDGH-0812	8-12		Zinc plated steel/SS201/304/316
GDGH-1016	10-16		Zinc plated steel/SS201/304/316
GDGH-1222	12-22	12	Zinc plated steel/SS201/304/316
GDGH-1627	16-27	12	Zinc plated steel/SS201/304/316
GDGH-2032	20-32	12	Zinc plated steel/SS201/304/316
GDGH-2540	25-40	12	Zinc plated steel/SS201/304/316
GDGH-3045	30-45	12	Zinc plated steel/SS201/304/316
GDGH-3550	35-50	12	Zinc plated steel/SS201/304/316
GDGH-4060	40-60	12	Zinc plated steel/SS201/304/316
GDGH-5070	50-70	12	Zinc plated steel/SS201/304/316
GDGH-6080	60-80	12	Zinc plated steel/SS201/304/316
GDGH-7090	70-90	12	Zinc plated steel/SS201/304/316
GDGH-80100	80-100	12	Zinc plated steel/SS201/304/316
GDGH-90110	90-110	12	Zinc plated steel/SS201/304/316
GDGH-100120	100-120	12	Zinc plated steel/SS201/304/316
GDGH-110130	110-130	12	Zinc plated steel/SS201/304/316
GDGH-120140	120-140	12	Zinc plated steel/SS201/304/316
GDGH-130150	130-150	12	Zinc plated steel/SS201/304/316
GDGH-140160	140-160	12	Zinc plated steel/SS201/304/316
GDGH-150170	150-170	12	Zinc plated steel/SS201/304/316
GDGH-160180	160-180	12	Zinc plated steel/SS201/304/316
GDGH-170190	170-190	12	Zinc plated steel/SS201/304/316

T Blot Hose Clamp



Material	Band	Bridge	Trunnion	Sleeving	Bolt
W1	Zinc plated steel	Zinc plated steel	Zinc plated steel	Zinc plated steel	Zinc plated steel
W2	SS201/301	SS201/301	Zinc plated steel	Zinc plated steel	Zinc plated steel
W4	SS201/301/304	SS201/301/304	SS201/301/304	SS201/301/304	Zinc plated steel
W5	SS316	SS316	SS316	SS316	Zinc plated steel

Item No.	Use Range/ Size(mm)	Band Width(mm)	Thickness (mm)	Screw	Material
GDTH-1719	17-19	18	0.6	M6x40	Zinc plated steel/SS201/304/316
GDTH-2022	20-22	18	0.6		Zinc plated steel/SS201/304/316
GDTH-2325	23-25	18	0.6		Zinc plated steel/SS201/304/316
GDTH-2628	26-28	18	0.6		Zinc plated steel/SS201/304/316
GDTH-2931	29-31	20	0.6	M6x50	Zinc plated steel/SS201/304/316
GDTH-3235	32-35	20	0.6		Zinc plated steel/SS201/304/316
GDTH-3639	36-39	20	0.6		Zinc plated steel/SS201/304/316
GDTH-4043	40-43	20	0.6		Zinc plated steel/SS201/304/316
GDTH-4447	44-47	22	0.8	M6x60	Zinc plated steel/SS201/304/316
GDTH-4851	48-51	22	0.8		Zinc plated steel/SS201/304/316
GDTH-5255	52-55	22	0.8		Zinc plated steel/SS201/304/316
GDTH-5659	56-59	22	0.8		Zinc plated steel/SS201/304/316
GDTH-6063	60-63	22	0.8		Zinc plated steel/SS201/304/316
GDTH-6467	64-67	22	0.8		Zinc plated steel/SS201/304/316
GDTH-6873	68-73	24	0.8	M8x70	Zinc plated steel/SS201/304/316
GDTH-7479	74-79	24	0.8		Zinc plated steel/SS201/304/316
GDTH-8085	80-85	24	0.8		Zinc plated steel/SS201/304/316
GDTH-8691	86-91	24	0.8		Zinc plated steel/SS201/304/316
GDTH-9297	92-97	24	0.8	M8x80	Zinc plated steel/SS201/304/316
GDTH-98103	98-103	24	0.8		Zinc plated steel/SS201/304/316
GDTH-104112	104-112	24	0.8		Zinc plated steel/SS201/304/316
GDTH-113121	113-121	24	0.8		Zinc plated steel/SS201/304/316
GDTH-122130	122-130	24	0.8		Zinc plated steel/SS201/304/316
GDTH-131139	131-139	26	1.0		Zinc plated steel/SS201/304/316
GDTH-140148	140-148	26	1.0		Zinc plated steel/SS201/304/316
GDTH-149161	149-161	26	1.0		Zinc plated steel/SS201/304/316
GDTH-162174	162-174	26	1.0		Zinc plated steel/SS201/304/316
GDTH-175187	175-187	26	1.0		Zinc plated steel/SS201/304/316
GDTH-188200	188-200	26	1.0	M10x90	Zinc plated steel/SS201/304/316
GDTH-201213	201-213	26	1.0		Zinc plated steel/SS201/304/316
GDTH-214226	214-226	26	1.0		Zinc plated steel/SS201/304/316
GDTH-227239	227-239	26	1.0		Zinc plated steel/SS201/304/316
GDTH-240252	240-252	26	1.0		Zinc plated steel/SS201/304/316

R TYPE CABLE CLAMP

Material: Nylon66 UL94V-2

Color: White/Black

Purpose: The wires and pipe fittings can be put into the wire clamp, and then fixed with screws, which is convenient and beautiful.

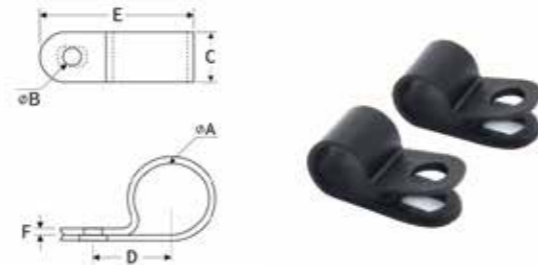

Material	Band	Bridge	Trunnion	Sleeving	Bolt
W1	Zinc plated steel	Zinc plated steel	Zinc plated steel	Zinc plated steel	Zinc plated steel
W2	SS201/301	SS201/301	Zinc plated steel	Zinc plated steel	Zinc plated steel
W4	SS201/301/304	SS201/301/304	SS201/301/304	SS201/301/304	Zinc plated steel
W5	SS316	SS316	SS316	SS316	Zinc plated steel

Item No.	A		B mm	C mm	D mm	E mm	F mm	Packing
	mm	inch						
GD-1/8R	3.2	1/8"	4.8	8	9.6	17	1.25	1000pcs
GD-3/16R	4.8	3/16"	4.8	9.5	10.3	19.5	1.25	1000pcs
GD-1/4R	6.35	1/4"	4.8	10	10	20	1.3	1000pcs
GD-5/16R	7.9	5/16"	4.8	12	10	22	1.5	1000pcs
GD-3/8R	9.5	3/8"	5	12.5	12	24	1.5	1000pcs
GD-1/2R	12.7	1/2"	5	15.2	12	31	1.5	1000pcs
GD-5/8R	15.8	5/8"	5	18.2	12	34.3	1.5	1000pcs
GD-3/4R	19.4	3/4"	5	18.2	12	35	1.5	1000pcs
GD-7/8R	22.23	7/8"	5	19.8	12	41	1.5	1000pcs
GD-1R	25.4	1"	5	22	12	43	1.8	1000pcs
1-1/16R	27	1 1/16"	5	24	12	50	1.8	1000pcs
1-1/4R	31.75	1 1/4"	5	26.2	12	46.2	1.8	1000pcs
1-1/2R	36.7	1 1/2"	5	30	12	50	1.8	1000pcs

Saddle Type Cable Tie Mount

Material: Nylon66,UL94 V-2

Application: Saddle design provide maximum stability to wire bundles.

To apply, simply fix mount with a screw and secure wire bundles with nylon cable ties.

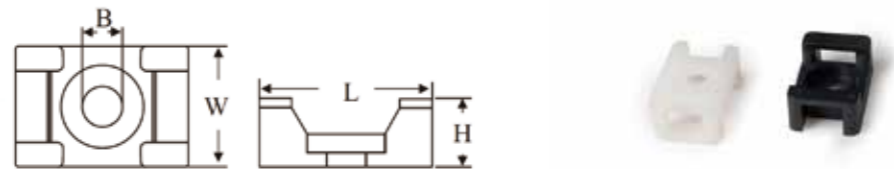

Item No.	L mm	W mm	H mm	Mounting Hole Size mm	Suit cable tie width
GDHC-1	15	10	7	4.1 or 3.5	5
GDHC-1S	12.6	7	5.7	3.3	4
GDHC-2	23	16	10	6.5	9
GDHC-2S	23	16	10	5	9
GDHC-5	23	16	10	4.5	9

Cable Tie Mount Plug

Material: Nylon66,UL94 V-2

Color: Natural, Black

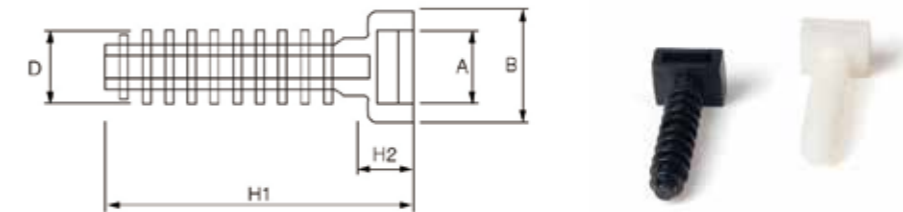

Item No.	D mm	H1 mm	H2 mm	A
GD-TMP-8	8	32	6	9.8
GD-TMP-10	10	36	6	9.8

ABS-CABLE TIE MOUNTS

Material: ABS, with imported adhesive sticker, Good insulation, long lasting and uneasy to age.

3M adhesive is available upon request.

How to use: Remove the cover of the adhesive and stick the piece properly, then put in cable tie for using.

Application: Used where hole-drilling is not allowed, easy and time-saving.

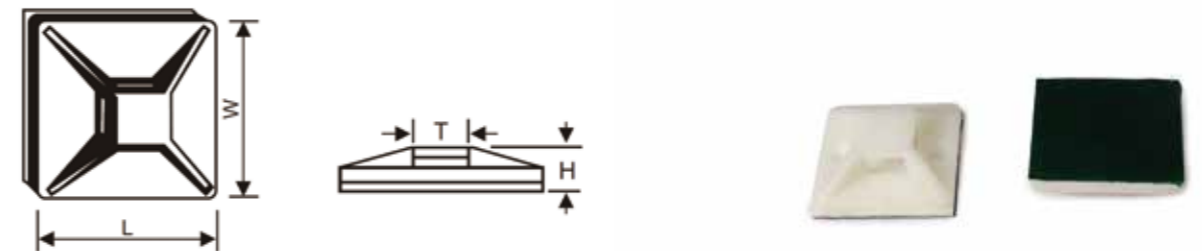

Item No.	LxW mm	H mm	T mm	Ctn Size cm	pcs/ctn
GD-20	20x20	6.1	5	52x35x36	20000
GD-25	25x25	7.5	6.2	52x35x36	10000
GD-30	30x30	8.7	6.4	54x33x32	6000
GD-40	40x40	6.4	10.8	54x33x32	3000

NYLON-CABLE TIE MOUNTS

Material: UL approved Nylon 66, 94V-2, with imported adhesive sticker, Good insulation, long lasting and uneasy to age.
3M adhesive is available upon request.

How to use: Remove the cover of the adhesive and stick the piece properly, then put in cable tie for using.

Application: Used where hole-drilling is not allowed, easy and time-saving.

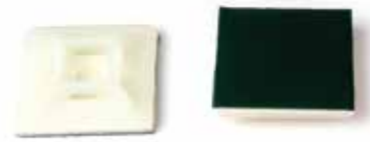

Item No.	LxW mm	A mm	B mm	C mm	D mm	E mm
GD-19	19x19	19.4	4.2	1.0	4.5	3.6
GD-28	28x28	28.0	6.4	1.5	5.8	6.0

CIRCLE NAIL CABLE CLIP

Material: PP, Steel nail.

How to use: Put the cable under the clip and hammer the nail into the wall to secure the cable.

Application: Securing of cables for general indoor wiring.

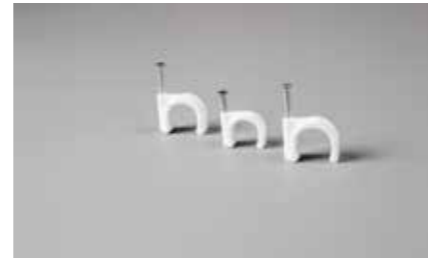
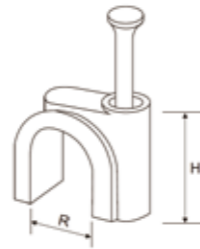

Size	H mm	R mm	Nail Size mm	Packing
4mm	5.3	4	1.7x15	100pcs
5mm	6.5	5	1.7x15	
6mm	8.1	6	1.7x17	
7mm	8.7	7	1.8x19	
8mm	9.6	8	1.9x21	
9mm	10.7	9	2.0x22	
10mm	11.7	10	2.05x25	
12mm	12.8	12	2.05x27	
14mm	14.9	14	2.4x32	
16mm	16.9	16	2.5x35	
18mm	20.8	18	2.5x37	
20mm	23.6	20	2.8x42	
22mm	25.0	22	2.8x48	
25mm	27.7	25	3.2x48	
30mm	33.1	30	3.2x53	
35mm	36.6	35	3.2x58	
40mm	45.2	40	3.4x6	

SQUARE NAIL CABLE CLIP

Material: PP, Steel nail.

How to use: Put the cable under the clip and hammer the nail into the wall to secure the cable.

Application: Securing of cables for general indoor wiring.

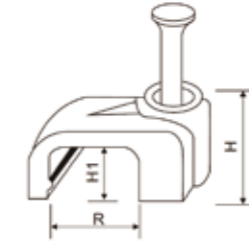

Size	H mm	H1 mm	R mm	Nail mm	Packing
4mm	6.0	3.8	4	1.7x15	100pcs
5mm	6.0	3.8	5	1.7x15	
6mm	6.5	4.1	6	1.7x16	
7mm	7.0	4.7	7	1.9x18	
8mm	7.5	5	8	2.05x20	
9mm	8.2	5.4	9	2.05x23	
10mm	8.6	5.7	10	2.3x23	
12mm	9.0	6.1	12	2.3x23	
14mm	11.2	6.5	14	2.4x30	

EXPAND NAILS

Color: White, Grey

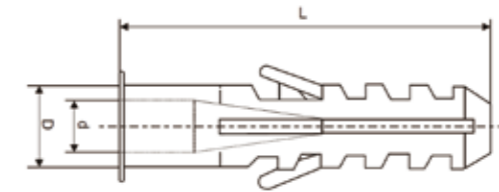

Item No.	Length mm	I.D. mm	O.D. mm
EN-06	29.8	6	4.9
EN-08	38.6	7.9	5.3
EN-10	42.7	9.9	5.8
EN-12	47.9	11.6	6.3

HEAT-SHRINKABLE TUBINGS

Shrinkage ratio: 2:1

Approved date: UL2240, 105C, 660V, VW-1, CSA, 125C, 660V, OFT

F: 105C (UL, CSA合格)

F2: 125C (UL, CSA合格)

F3: 125C (UL, DSA合格)

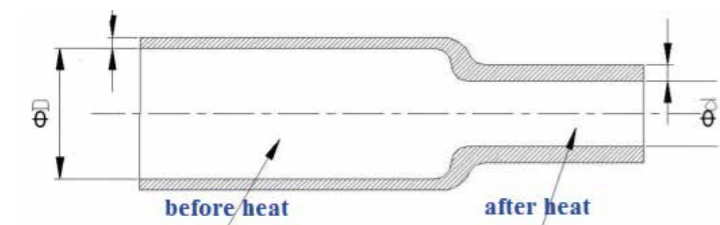

Item No.	As Supplied I.D(mm)	Thickness	After Shrinkage I.D (mm)	Thickness	Packing (M/Roll)	
GD-1	1	0.2±0.05	0.5	0.4±0.05	400	
GD-1.5	1.5	0.2±0.05	0.75	0.4±0.05	300	
GD-2	2	0.25±0.05	1	0.45±0.1	200	
GD-2.5	2.5	0.25±0.05	1.25	0.45±0.1		
GD-3	3	0.25±0.05	1.5	0.45±0.1		
GD-3.5	.5	0.25±0.05	1.75	0.45±0.1		
GD-4	4	0.25±0.05	2	0.45±0.1		
GD-5	5	0.35±0.05	2.5	0.55±0.1		
GD-6	6	0.35±0.05	3	0.55±0.1		
GD-7	7	0.35±0.05	3.5	0.55±0.1		
GD-8	8	0.35±0.05	4	0.55±0.1		
GD-9	9	0.35±0.05	4.5	0.55±0.1		
GD-10	10	0.35±0.05	5	0.60±0.1	100	
GD-11	11	0.35±0.05	5.5	0.60±0.1		
GD-12	12	0.35±0.1	6	0.70±0.1		
GD-13	13	0.35±0.1	6.5	0.70±0.1		
GD-14	14	0.35±0.1	7	0.70±0.1		
GD-15	15	0.35±0.1	7.5	0.70±0.1		
GD-16	16	0.35±0.1	8	0.70±0.1		
GD-17	17	0.35±0.1	8.5	0.70±0.1		
GD-18	18	0.4±0.1	9	0.80±0.1		
GD-20	20	0.5±0.1	10	0.90±0.1		50
GD-22	22	0.5±0.1	11	0.90±0.1		
GD-25	25	0.5±0.1	12.5	0.90±0.1		
GD-28	28	0.5±0.1	14	0.90±0.1		
GD-30	30	0.5±0.1	15	1.00±0.2		
GD-35	35	0.5±0.1	17.5	1.00±0.2		
GD-40	40	0.5±0.1	20	1.00±0.2		
GD-50	50	0.5±0.1	25	1.00±0.2		
GD-60	60	0.6±0.1	30	1.20±0.2	25	
GD-70	70	0.6±0.1	35	1.20±0.2		
GD-80	80	0.6±0.1	40	1.20±0.2		
GD-90	90	0.6±0.1	45	1.30±0.2		
GD-100	100	0.7±0.1	50	1.30±0.2		
GD-150	150	0.8±0.1	75	1.60±0.2		

SPIRAL WRAPPING BAND

Material: PE

Usage: Fix one end with safety belt first, then circle the wires clockwise to make them tightened.

Application: Protect electric wires from wearing, as insulation for electric wires and make the looks nice.

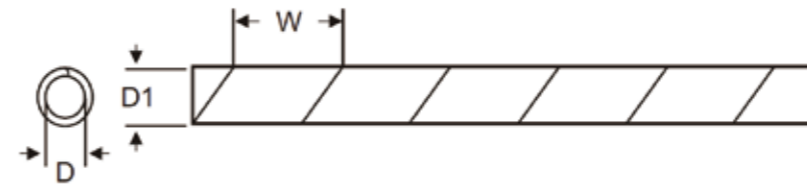

Item No.	D	D1	W	Wrapping range mm
GD-6SW	4	6	7	4x50
GD-8SW	6	8	10.8	6x60
GD-10SW	7.5	10	11.4	7.5x60
GD-12SW	9	12	13.9	9x65
GD-16SW	13	16	15	12x70
GD-20SW	16	20	18.2	15x100
GD-25SW	21	25	19.6	20x130

SPIRAL WRAPPING BAND



Item No.	Size	Packing	
GD-15A	Φ15mm	2.5m	10m
GD-20A	Φ20mm		
GD-25A	Φ25mm		
GD-30A	Φ30mm		

ECM-TYPE WIRE MARKERS

Material: Soft PVC,concave conversed shape,ode word printed on the sleeve,big elasticity of inner diameter.How to use:Peel each hack lightly
 Feature: Suitable for any size of wires,length and special marking is available to order.



Item No.	Suitable Wire	In-Diameter	Length	No.
GEC-0	18AWG	2.0-3.0	3.5	
	16AWG			
	0.75			
GEC-1	0.75	3.0-5.2	4	4
	1.25			
	2.0			
	3.0			
GEC-2	3.5	3.6-7.4	5	A-Z
	5.5			
	8.0			
GEC-3	8.0	5.2-10.0	5	
	14.0			
	22.0			

FLAT CABLE MARKER

Material: Made of finest soft grade, strong, durable PVC that will resist oil, grease and other material erosion.

FLAT CABLE MARKER with its unique oval shape design provide.

1. slip over cable directly (for small cable).
2. slip onto marker strip (for larger cable or cable bundles).



Item No.	Suitable Wire		Suitable range	Length	Std. Markings	Packing
	sq	awg				
FM-1	2.0~8	14~8	3.5~7.0	5.0	0,1,2,3, ...9 A,B,C,D,...Z +,-/,Blank	500pcs/Roll

CARRIER MARKER STRIPS

Material: PE

Usage: Fix one end with safety belt first,then circle the wires clockwise to make themtightened.

Application: Protect electric wires from wearing,as insulation for electric wires and make the looks nice.

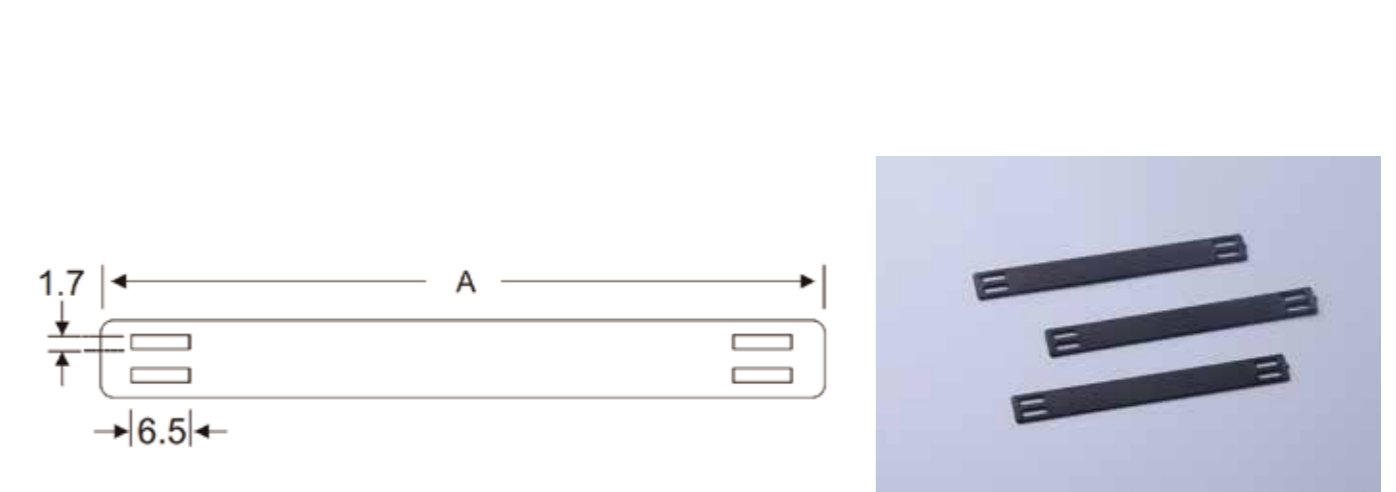

Item No.	Item No.		Length	Packing
	White	Black		
MS-65	MS-65B	66	100pcs	
MS-100	MS-100B	103		
MS-135	MS-135B	135		

INSULATING DISTRIBUTING SLOT

Material: Made from PVCd(grey),well insulation,Fire-retardant and heat-resistant is up to 85°C.
 Application: Suitable for open wire's distributing of sftage,electric,cold air engineering and indoors.
 Structure: Made up of duct bottom and lid,with two out-holes designed at the bootm.

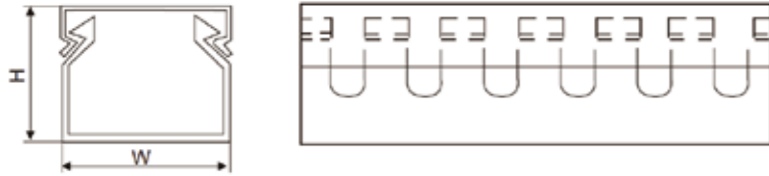

Item No.	HxW (mm)	Contained wire(2.0)	Length
PXC3-2015	20x15	5-10 PCS	2m
PXC3-2025	20x25	5-15 PCS	2m
PXC3-2525	25x25	10-20 PCS	2m
PXC3-3015	30x15	5-15 PCS	2m
PXC3-3020	30x20	10-20 PCS	2m
PXC3-3025	30x25	15-25 PCS	2m
PXC3-3030	30x30	20-40 PCS	2m
PXC3-3035	30x35	35-45 PCS	2m
PXC3-3045	30x45	40-55 PCS	2m
PXC3-3530	35x30	30-45 PCS	2m
PXC3-3535	35x35	35-50 PCS	2m
PXC3-3540	35x40	50-60 PCS	2m
PXC3-4025	40x25	20-25 PCS	2m
PXC3-4030	40x30	35-45 PCS	2m
PXC3-4040	40x40	60-70 PCS	2m
PXC3-5015	50x15	10-25 PCS	2m
PXC3-5025	50x25	25-45 PCS	2m
PXC3-5030	50x30	30-50 PCS	2m
PXC3-5035	50x35	50-60 PCS	2m
PXC3-5040	50x40	60-70 PCS	2m
PXC3-5045	50x45	70-80 PCS	2m
PXC3-5050	50x50	80-90 PCS	2m
PXC3-5055	50x55	100-110 PCS	2m
PXC3-5080	50x80	180-200 PCS	2m
PXC3-50100	50x100	210-260 PCS	2m
PXC3-8045	80x45	160-180 PCS	2m
PXC3-8050	80x50	180-200 PCS	2m
PXC3-8055	80x55	180-210 PCS	2m
PXC3-8080	80x80	240-290 PCS	2m
PXC3-80100	80x100	260-350 PCS	2m
PXC3-100100	100x100	300-400PCS	2m

PEC ARCHITECTURE & DECORATING WIRE DUCT

Material: Made from PVCd(white),well insulation,Fire-retardant and heat-resistant is up to 85°C.
 Application: Suitable for open wire's distributing of sftage,electric,cold air engineering and indoors.
 Charactefr: Sealed insulating distributing slot is designed specially for dus proof and mouse proof.

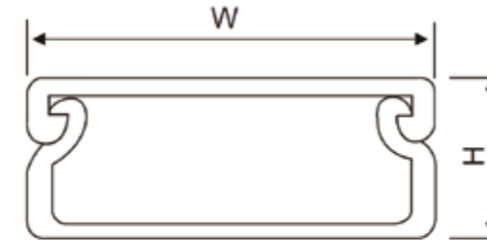

Item No.	HxW (mm)	Contained wire(2.0)	Length
PEC-1015	10x15	2-5 PCS	2m
PEC-1020	10x20	3-6 PCS	2m
PEC-1025	10x25	5-10 PCS	2m
PEC-1035	10x35	10-15 PCS	2m
PEC-1525	15x25	5-10 PCS	2m
PEC-1530	15x30	5-15 PCS	2m
PEC-2030	20x30	10-20 PCS	2m
PEC-2035	20x35	15-25 PCS	2m
PEC-2050	20x50	20-25 PCS	2m
PEC-2540	25x40	20-40 PCS	2m
PEC-3045	30x45	25-45 PCS	2m
PEC-3050	30x50	30-50 PCS	2m
PEC-3060	30x60	55-65 PCS	2m
PEC-3080	30x80	75-85 PCS	2m
PEC-30100	30x100	130-150 PCS	2m
PEC-5015	50x15	10-25 PCS	2m
PEC-5025	50x25	25-45 PCS	2m
PEC-5035	50x35	50-60 PCS	2m
PEC-5045	50x45	70-80 PCS	2m
PEC-5050	50x50	80-90 PCS	2m
PEC-5055	50x55	100-110 PCS	2m
PEC-5080	50x80	180-200 PCS	2m
PEC-8045	80x45	160-180 PCS	2m
PEC-8050	80x50	180-200 PCS	2m
PEC-8055	80x55	180-210 PCS	2m
PEC-8080	80x80	240-290 PCS	2m
PEC-80100	80x100	260-350 PCS	2m
PEC-50100	50x100	200-260 PCS	2m
PEC-50120	50x120	240-290 PCS	2m
PEC-80120	80x120	300-400 PCS	2m
PEC-100160	100x160	450-600 PCS	2m
PEC-160200	160x200	1040-1200 PCS	2m